

Mandrino per pinza ER 20
Spindle for collet ER 20

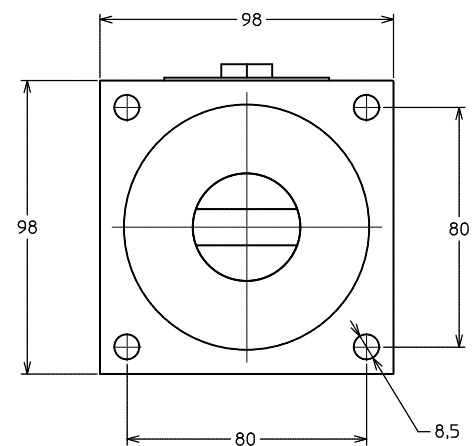

TESTA ANGOLARE TIPO A20/N / ANGLE HEAD TYPE A20/N

SPECIFICHE TECNICHE / TECHNICAL SPECIFICATION

Modello / Type	A20/N
Codice / Code	114904.100
Mandrino per pinza / Spindle for collet	ER 20
Rotazione presa di forza / Main drive rotation	SX / LH
Rotazione mandrino / Spindle rotation	DX / RH
Rapporto di trasmissione / Transmission ratio	1:1
Velocità max / Max speed	5000 RPM
Peso / Weight	

ACCESSORI / ACCESSORIES

Chiave / Wrench	410420.000
Pinza / Collet	411220.100